

# Hackujeme autobus

Tomáš Tichý

LinuxDays 2024

13. října 2024



Uvedené dílo podléhá licenci Creative Commons Uveďte autora 3.0 Česko.

# Něco o mně

## Něco o mně

- Linuxák od roku 2006



<https://tichytom.cz/>

# Něco o mně

## Něco o mně

- Linuxák od roku 2006
- Milovník chameleonů od 2007

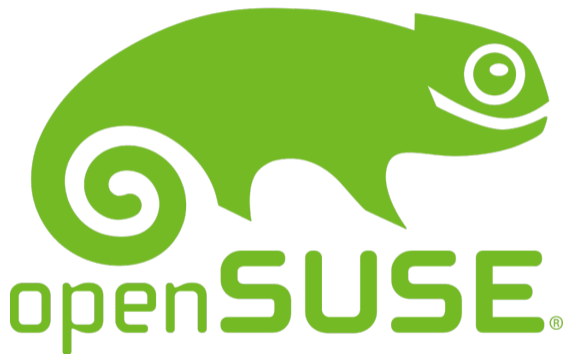

<https://tichydom.cz/>

# Něco o mně

## Něco o mně

- Linuxák od roku 2006
- Milovník chameleonů od 2007



<https://tichydom.cz/>

# Něco o mně

## Něco o mně

- Linuxák od roku 2006
- Milovník chameleonů od 2007
- Šotouš



<https://tichydom.cz/>

# Něco o mně

## Něco o mně

- Linuxák od roku 2006
- Milovník chameleonů od 2007
- Šotouš
- Amatérský fotograf



<https://tichytom.cz/>

# Něco o mně

## Něco o mně

- Linuxák od roku 2006
- Milovník chameleonů od 2007
- Šotouš
- Amatérský fotograf
- Sběratel OIS



<https://tichydom.cz/>

# Něco o mně

## Něco o mně

- Linuxák od roku 2006
- Milovník chameleonů od 2007
- Šotouš
- Amatérský fotograf
- Sběratel OIS
- Od 2022 řiditel autobusu
- <https://mamautobus.cz>



<https://tichydom.cz/>



# Něco o mně

## Něco o mně

- Linuxák od roku 2006
- Milovník chameleonů od 2007
- Šotouš
- Amatéřský fotograf
- Sběratel OIS
- Od 2022 řiditel autobusu
- <https://mamautobus.cz>
- Od září 2023 polovodič autobusu u DPP



<https://tichydom.cz/>

# Co nás čeká

- 1 Historie
- 2 Co vše tvoří IS v MHD
- 3 IBIS
- 4 Mnemo jazyk
- 5 Nové systémy
- 6 Závěr

# Historie



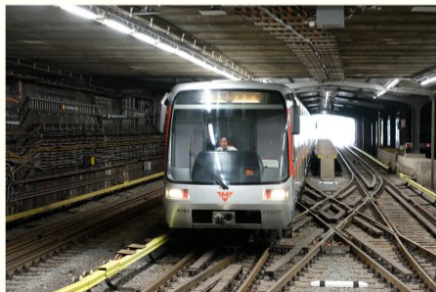





























Tomáš Tichý (LinuxDays 2024)



Hackujeme autobus



Tomáš Tichý (LinuxDays 2024)



Hackujeme autobus



Tomáš Tichý (LinuxDays 2024)



Hackujeme autobus



Tomáš Tichý (LinuxDays 2024)



Hackujeme autobus



Tomáš Tichý (LinuxDays 2024)



Hackujeme autobus



Tomáš Tichý (LinuxDays 2024)



Hackujeme autobus

# Co vše tvoří IS v MHD













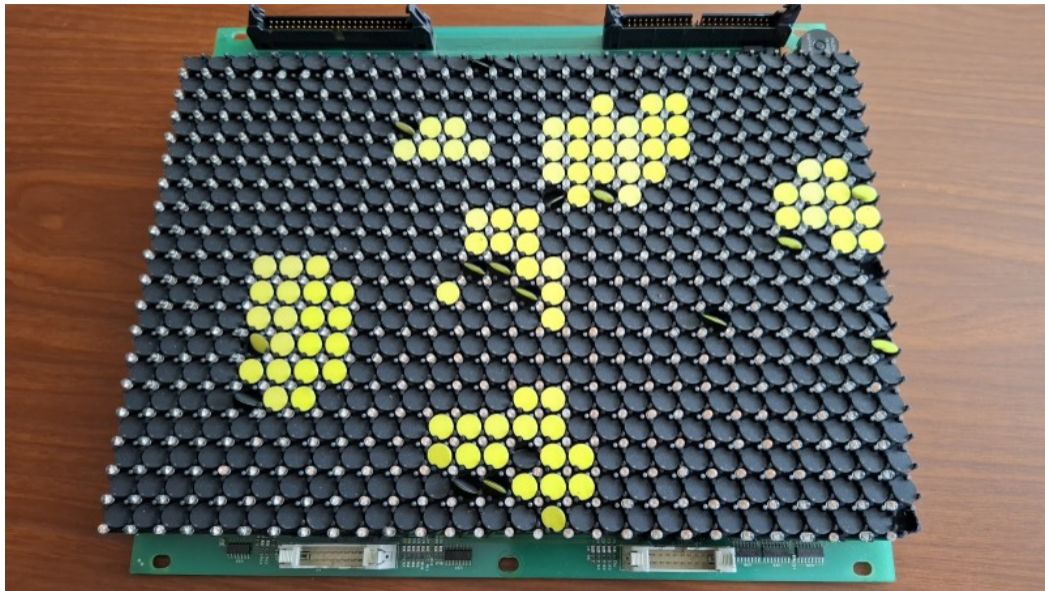















# IBIS



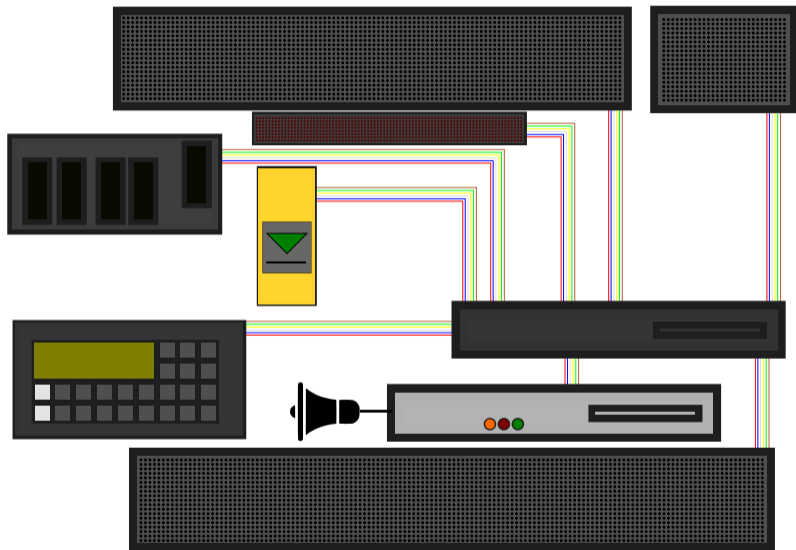

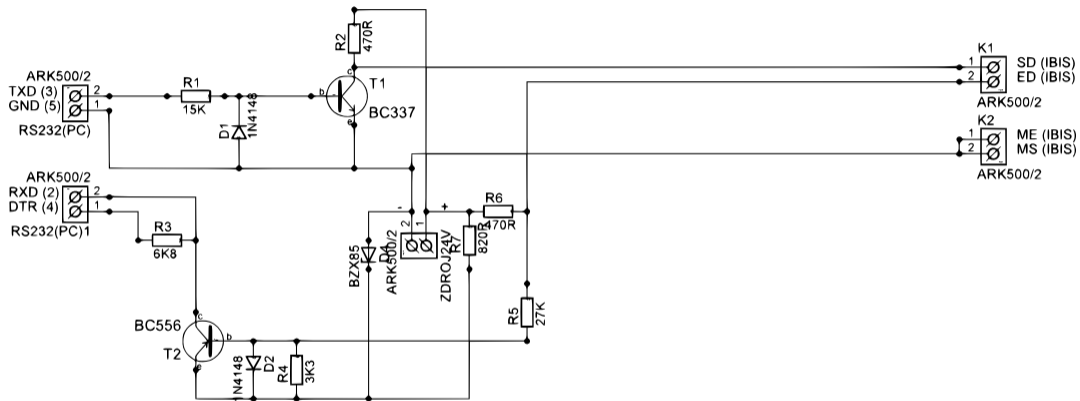

Zdroj: [https://jachyhm.cz/ois/Schemata/IBIS-COM\\_kompletni\\_schema.jpg](https://jachyhm.cz/ois/Schemata/IBIS-COM_kompletni_schema.jpg)

Odposlechnutá data z BSLoader 4.02:

Baudrate 1200 bps, parita sudá, 7 databitů a 2 stop bity

povel	HEX	význam	BIN
xC0	78 43 30 0D 79	povel,CR,KS	01111000 01000011 0011000000001101 01111001
xC1	78 43 31 0D 78	povel,CR,KS	01111000 01000011 0011000100001101 01111000
u2019	75 32 30 31 39 0D 0D	povel,CR,KS	01110101 00110010 00110000 00110001 00111001 00001101 00001101
u2020	75 32 30 32 30 0D 07	povel,CR,KS	01110101 00110010 00110000 00110010 00110000 00001101 00000111
u2021	75 32 30 32 31 0D 06	povel,CR,KS	01110101 00110010 00110000 00110010 00110001 00001101 00000110

\*KS = kontrolní součet

CR = Carriage Return = návrat vozíku = \r

Červená data tedy KS je výsledek XORu všech znaků povelu včetně 0x0D (CR) a k nim 0x7F.

příklad pro „xC0“ (v HEX) :  $7F \oplus 78 \oplus 43 \oplus 30 \oplus 0D = 79$  / kde ^ zastupuje funkci XOR

U XORu nezáleží na pořadí prvků, tedy XOR 0x7F můžeme udělat kdykoliv.

Mimoходом děkuji uživateli VroutekB Danykova diskuzního kroužku, který přišel právě na XOR s 0x7F.

Zdroj: <https://pavlik.space/ibis-bs120>



## Příkazy IBIS

<b>l</b> <sub>xyz</sub>	číslo linky
<b>zC</b> <sub>xyz</sub>	konečná zastávka
<b>zD</b> <sub>xyz</sub>	nácestná zastávka
<b>e</b> <sub>xyz</sub>	tarifní pásmo
<b>u</b> <sub>hhmm</sub>	čas
<b>x</b> <sub>xyz</sub>	příští zastávka
<b>xC</b> <sub>x</sub>	číslo cyklu

## Čísla

<b>x</b>	0 - 9
<b>xyz</b>	000 - 999
<b>xyz</b>	0000 - 9999
<b>hhmm</b>	0000 - 2359

## Znaková sada

##	.0	.1	.2	.3	.4	.5	.6	.7	.8	.9	.A	.B	.C	.D	.E	.F
8.	Č 10C	ü FC	é E9	d' 10F	ä E4	Ď 10E	Ť 164	č 10D	ě 11B	Ě 11A	Í 139	í CD	ı 13E	Í 13A	Ä C4	Á C1
9.	É C9	ž 17E	Ž 17D	ô F4	ö F6	Ó D3	û 16F	Ú DA	ý FD	Ö D6	Ü DC	Š 160	Ł 13D	Ý DD	Ř 158	ť 165
A.	á E1	í ED	ó F3	ú FA	ň 148	Ñ 147	Ů 16E	Ô D4	š 161	ř 159	í 155	Ř 154	¼ BC	§ A7	« AB	» BB
B.	 2591	 2592	 2593	 2502	┆ 2524	┆ 2561	┆ 2562	π 2556	ϣ 2555	┆ 2563	 2551	┆ 2557	┆ 255D	┆ 255C	┆ 255B	┆ 2510
C.	┆ 2514	┆ 2534	┆ 252C	┆ 251C	— 2500	┆ 253C	┆ 255E	┆ 255F	┆ 255A	┆ 2554	┆ 2569	┆ 2566	┆ 2560	┆ 2550	┆ 256C	┆ 2567
D.	┆ 2568	┆ 2564	┆ 2565	┆ 2559	┆ 2558	┆ 2552	┆ 2553	┆ 256B	┆ 256A	┆ 2518	┆ 250C	■ 2588	■ 2584	┆ 258C	┆ 2590	■ 2580
E.	α 3B1	β DF	Γ 393	π 3C0	Σ 3A3	σ 3C3	μ B5	τ 3C4	Φ 3A6	Θ 398	Ω 3A9	δ 3B4	∞ 221E	φ 3C6	ε 3B5	∩ 2229
F.	≡ 2261	± B1	≥ 2265	≤ 2264	∫ 2320	∫ 2321	÷ F7	≈ 2248	° B0	· 2219	· B7	√ 221A	n 207F	² B2	■ 25A0	A0

# Mnemo jazyk

## Mnemo jazyk

'text' Vypíše text mezi  
#xyz Vypíše znak

## Řídící příkazy

**f<sub>x</sub>** výběr fontu  
**i** začátek / konec inverze  
**m<sub>x</sub>** velikost mezery  
**s<sub>xyz</sub>** posun textu vodorovně  
**y<sub>xy</sub>** posun textu svisle  
**z<sub>xyz</sub>** čas zobrazení textu

## Ukončující znaky

**LF** nový řádek  
**VT** opakování výpisu  
**FF** formátování textu  
**CR** Ukončení sekvence

## Čísla

x 0 - 9  
xy 0 - 99  
xyz 0 - 999

## Vnitřní panel

- t0** statický text
- t1** rolující text
- t2** stoupající text
- t3** padající text

## Vnější panely

- b** rozšíří text
- |** další spodní text
- p** posunutí textu a zarovnání vpravo
- s** posunutí textu a zarovnání vlevo



### Příklad Mnemo

```
f5 m1 y1 '2024' CR
f3 m2 y0 '> LINUXDAYS' CR
f0 m2 y0 '13. října 2024' CR
```

### Příklad IBIS

```
1024
zC9000
zD9000
```



### Příklad Mnemo

```
b 11 f7 y0 #251 FF f3 m1 y0 'konference LinuxDays' LF  
f0 m1 y10 'ČVUT v Praze,13.října 2024' CR
```

### Příklad IBIS

```
zC9001
```





### Příklad Mnemo

```
b p112 f7 y0 #251 FF f8 m1 y1 'HACKUJEME' f9 ' ' f8 'BUS' CR
```

### Příklad IBIS

```
1700
```



### Příklad Mnemo

```
b 11 f8 s1 y0 #255 f9 s29 #255 f10 s57 #255 f11 s85 #255 FF CR
```

### Příklad IBIS

```
zC6666
```



## Příklad Mnemo

```
b 11 f7 y0 #251 FF f3 m1 y0 'konference LinuxDays' LF
f0 m1 y10 'je největší akcí zaměřenou' LF
'na Linux v Česku. Letos se' LF
'uskuteční ve dnech 12. a 13.' LF
'října 2024 na FIT ČVUT info' LF
'https://www.linuxdays.cz' LF
' ' VT CR
```

## Příklad IBIS

```
zC9002
```



## Příklad Mnemo

```
b 11 f7 y0 #251 FF f3 m1 y0 'konference LinuxDays' LF
f0 m1 y10 'je největší akcí zaměřenou' LF
'na Linux v Česku. Letos se' LF
'uskuteční ve dnech 12. a 13.' LF
'října 2024 na FIT ČVUT info' LF
'https://www.linuxdays.cz' LF
' ' VT CR
```

## Příklad IBIS

```
zC9002
```



## Příklad Mnemo

```
b 11 f7 y0 #251 FF f3 m1 y0 'konference LinuxDays' LF
f0 m1 y10 'je největší akcí zaměřenou' LF
'na Linux v Česku. Letos se' LF
'uskuteční ve dnech 12. a 13.' LF
'října 2024 na FIT ČVUT info' LF
'https://www.linuxdays.cz' LF
' ' VT CR
```

## Příklad IBIS

```
zC9002
```



## Příklad Mnemo

```
b 11 f7 y0 #251 FF f3 m1 y0 'konference LinuxDays' LF
f0 m1 y10 'je největší akcí zaměřenou' LF
'na Linux v Česku. Letos se' LF
'uskuteční ve dnech 12. a 13.' LF
'října 2024 na FIT ČVUT info' LF
'https://www.linuxdays.cz' LF
' ' VT CR
```

## Příklad IBIS

```
zC9002
```



## Příklad Mnemo

```
b 11 f7 y0 #251 FF f3 m1 y0 'konference LinuxDays' LF
f0 m1 y10 'je největší akcí zaměřenou' LF
'na Linux v Česku. Letos se' LF
'uskuteční ve dnech 12. a 13.' LF
'října 2024 na FIT ČVUT info' LF
'https://www.linuxdays.cz' LF
' ' VT CR
```

## Příklad IBIS

```
zC9002
```



## Příklad Mnemo

```
b 11 f7 y0 #251 FF f3 m1 y0 'konference LinuxDays' LF
f0 m1 y10 'je největší akcí zaměřenou' LF
'na Linux v Česku. Letos se' LF
'uskuteční ve dnech 12. a 13.' LF
'října 2024 na FIT ČVUT info' LF
'https://www.linuxdays.cz' LF
' ' VT CR
```

## Příklad IBIS

```
zC9002
```





## Příklad Mnemo

```
b 11 f7 y0 #251 FF f3 m1 y0 'konference LinuxDays' LF
f0 m1 y10 'je největší akcí zaměřenou' LF
'na Linux v Česku. Letos se' LF
'uskuteční ve dnech 12. a 13.' LF
'října 2024 na FIT ČVUT info' LF
'https://www.linuxdays.cz' LF
' ' VT CR
```

## Příklad IBIS

```
zC9002
```



## Příklad Mnemo

```
b 11 f7 y0 #251 FF f3 m1 y0 'konference LinuxDays' LF
f0 m1 y10 'je největší akcí zaměřenou' LF
'na Linux v Česku. Letos se' LF
'uskuteční ve dnech 12. a 13.' LF
'října 2024 na FIT ČVUT info' LF
'https://www.linuxdays.cz' LF
' ' VT CR
```

## Příklad IBIS

```
zC9002
```



## Příklad Mnemo

```
b 11 f7 y0 #251 FF f3 m1 y0 'konference LinuxDays' LF
f0 m1 y10 'je největší akcí zaměřenou' LF
'na Linux v Česku. Letos se' LF
'uskuteční ve dnech 12. a 13.' LF
'října 2024 na FIT ČVUT info' LF
'https://www.linuxdays.cz' LF
' ' VT CR
```

## Příklad IBIS

```
zC9002
```



## Příklad Mnemo

```
b 11 f7 y0 #251 FF f3 m1 y0 'konference LinuxDays' LF
f0 m1 y10 'je největší akcí zaměřenou' LF
'na Linux v Česku. Letos se' LF
'uskuteční ve dnech 12. a 13.' LF
'října 2024 na FIT ČVUT info' LF
'https://www.linuxdays.cz' LF
' ' VT CR
```

## Příklad IBIS

```
zC9002
```



## Příklad Mnemo

```
b 11 f7 y0 #251 FF f3 m1 y0 'konference LinuxDays' LF
f0 m1 y10 'je největší akcí zaměřenou' LF
'na Linux v Česku. Letos se' LF
'uskuteční ve dnech 12. a 13.' LF
'října 2024 na FIT ČVUT info' LF
'https://www.linuxdays.cz' LF
' ' VT CR
```

## Příklad IBIS

```
zC9002
```



## Příklad Mnemo

```
b 11 f7 y0 #251 FF f3 m1 y0 'konference LinuxDays' LF
f0 m1 y10 'je největší akcí zaměřenou' LF
'na Linux v Česku. Letos se' LF
'uskuteční ve dnech 12. a 13.' LF
'října 2024 na FIT ČVUT info' LF
'https://www.linuxdays.cz' LF
' ' VT CR
```

## Příklad IBIS

```
zC9002
```



## Příklad Mnemo

```
b 11 f7 y0 #251 FF f3 m1 y0 'konference LinuxDays' LF
f0 m1 y10 'je největší akcí zaměřenou' LF
'na Linux v Česku. Letos se' LF
'uskuteční ve dnech 12. a 13.' LF
'října 2024 na FIT ČVUT info' LF
'https://www.linuxdays.cz' LF
' ' VT CR
```

## Příklad IBIS

```
zC9002
```

# Tramvajové trable





# Tramvajové trable



# Tramvajové trable



# Tramvajové trable



# Tramvajové trable



# Nové systémy









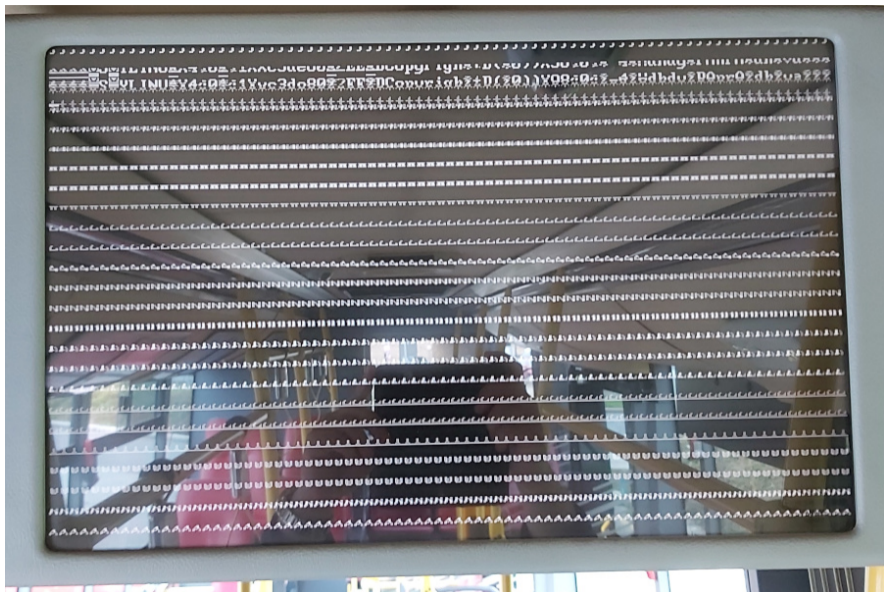

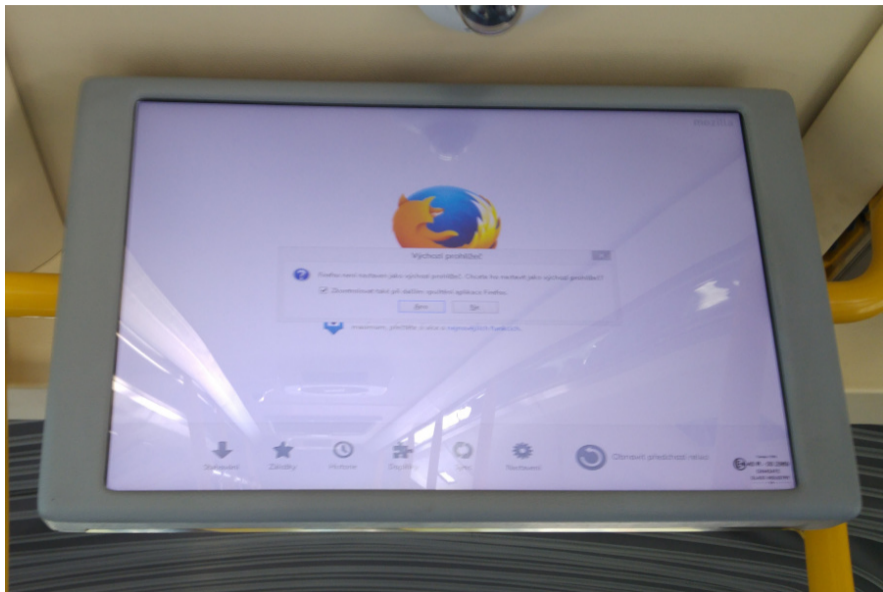

**154** → **HÁJE**

Konečná zastávka / Final stop

Přes zastávky / Via

- Nádr. Hor. Měcholupy - Sídliště Petrov

**23:27**

Pásmo / Zone

**P** **Strašnická**

**P** Na Hroudě

**P** Staré Strašnice

**P** Korytná

**P** Želivecká

SESU 1.1.11 E 43A

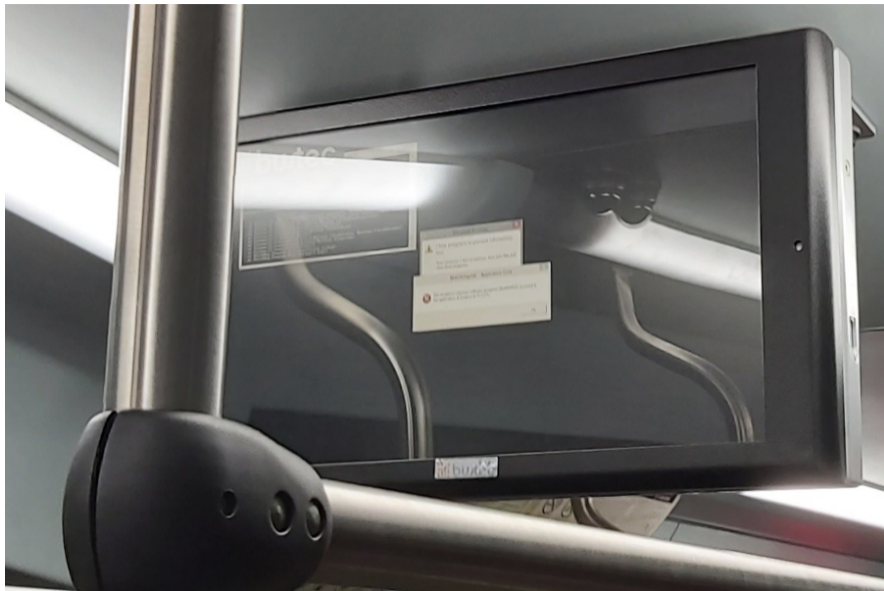







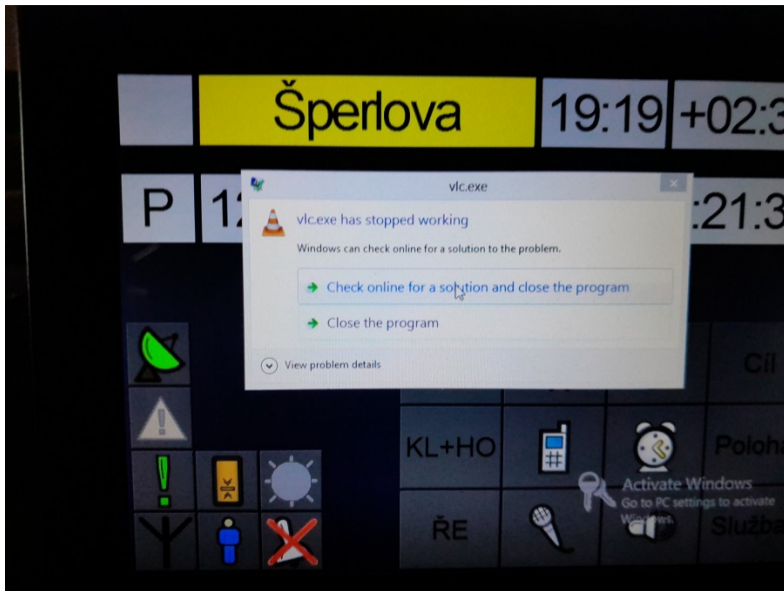



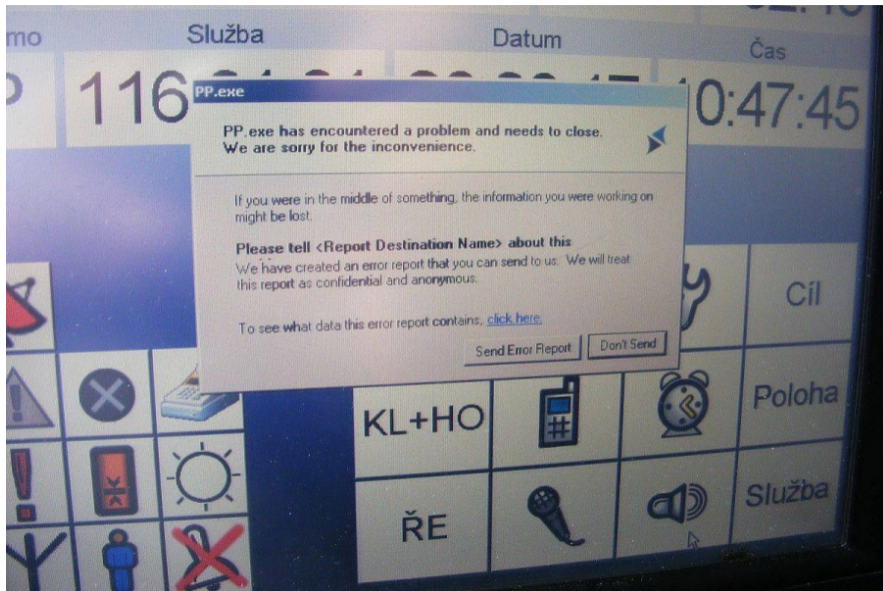

Linka / Line

**MJ**

Konečná zastávka /Final stop



Přes zastávky /Via

Čas / Time

**15:44**

Linka / Line

**MJ**

Konečná zastávka /Final stop



Přes zastávky /Via

Čas / Time

**15:44**

Linka / Line

**176**

Konečná zastávka /Final stop

Přes zastávky /Via

Čas / Time

**15:44**

Linka / Line

**176**

Konečná zastávka /Final stop

**→ STADION STRAHOV**

Přes zastávky /Via

Čas / Time

**15:44**

Linka / Line

**176**

Konečná zastávka /Final stop

**→ STADION STRAHOV**

Přes zastávky /Via

Čas / Time

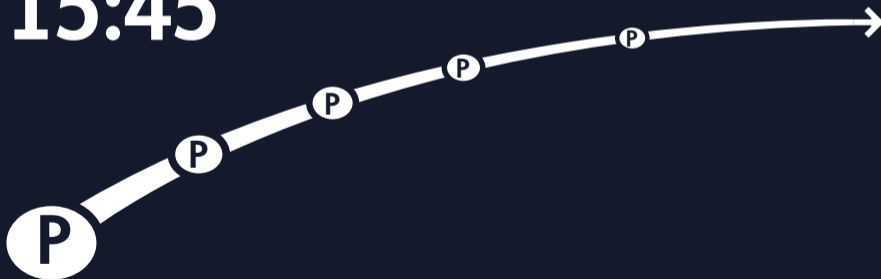
**15:45**

Linka / Line

**176**

Konečná zastávka /Final stop

**→ STADION STRAHOV**

Přes zastávky /Via

Čas / Time

**15:45**

Linka / Line

**176**

Konečná zastávka /Final stop

**→ STADION STRAHOV**

Přes zastávky /Via

**Jiráskovo náměstí - Švandovo divadlo**

Čas / Time

**15:45**



Linka / Line

**176**

Konečná zastávka /Final stop

**→ STADION STRAHOV**

Přes zastávky /Via

**Jiráskovo náměstí - Švandovo divadlo**

Čas / Time

**15:45**

Linka / Line

**176**

Konečná zastávka /Final stop

**→ STADION STRAHOV**

Přes zastávky /Via

**Jiráskovo náměstí - Švandovo divadlo**

Čas / Time

**15:46**

Linka / Line

**176**

Konečná zastávka /Final stop

**→ STADION STRAHOV**

Přes zastávky /Via

**Jiráskovo náměstí - Švandovo divadlo**

Čas / Time

**15:46**

Linka / Line

**176**

Konečná zastávka /Final stop

**→ STADION STRAHOV**

Přes zastávky /Via

**Jiráskovo náměstí - Švandovo divadlo**

Čas / Time

**15:46**

Linka / Line

**176**

Konečná zastávka /Final stop

**→ STADION STRAHOV**

Přes zastávky /Via

**Jiráskovo náměstí - Švandovo divadlo**

Čas / Time

**15:46**

Linka / Line

**176**

Konečná zastávka /Final stop

**→ STADION STRAHOV**

Přes zastávky /Via

**Jiráskovo náměstí - Švandovo divadlo**

Čas / Time

**15:46**

Linka / Line

**176**

Konečná zastávka /Final stop

**→ STADION STRAHOV**

Přes zastávky /Via

**Jiráskovo náměstí - Švandovo divadlo**

Čas / Time

**15:46**

Linka / Line

**176**

Konečná zastávka /Final stop

**→ STADION STRAHOV**

Přes zastávky /Via

**Jiráskovo náměstí - Švandovo divadlo**

Čas / Time

**15:46**





# 14

Výchozí zastávka / Starting stop  
**SPOŘILOV**

Neděle 13. 10. 15:48

Cíl / Destination

**VLTAVSKÁ**

Příští zastávka / Next stop  
**Bílá Labuť**

Těšnov  
Štvanice  
Vltavská  
Strossmayerovo nám.  
Kamenická  
Letenské náměstí  
Korunovační  
Sparta  
Chotkovy sady  
Malostranská  
Malostranské náměstí  
Hellichova  
Újezd  
Švandovo divadlo



14

Výchozí zastávka / Starting stop  
**SPOŘILOV**

Tato zastávka / This stop  
**Bílá Labuť**

**Neděle 13. 10. 15:48**

Cíl / Destination  
**VLTAVSKÁ**

Těšnov Štvanice **Vltavská** Strossmayerovo nám. Kamenická Letenské náměstí Korunovační Sparta Chotkovy sady Malostranská **Malostranské náměstí** Hellichova Újezd Švandovo divadlo .....



14

Výchozí zastávka / Starting stop  
**SPOŘILOV**

Tato zastávka / This stop  
**Bílá Labuť**

**Neděle 13. 10. 15:48**

Cíl / Destination  
**VLTAVSKÁ**

Těšnov   
 Štvanice   
**Vltavská**    
 Strossmayerovo nám.   
 Kamenická   
 Letenské náměstí   
 Korunovační   
 Sparta   
 Chotkovy sady   
 Malostranská   
 Malostranské náměstí   
 Hellichova   
 Újezd   
 Švandovo divadlo   
 .....



14

Výchozí zastávka / Starting stop  
**SPOŘILOV**

Příští zastávka / Next stop  
**Těšnov**  
Zastávka na znamení / Request stop

**Neděle 13. 10. 15:49**

Cíl / Destination  
**VLTAVSKÁ**

Štvanice

Vltavská

Štrossmayerovo nám.

Kamenická

Letenské náměstí

Korunovační

Sparta

Chotkovy sady

Malostranská

Hellichova

Újezd

Švandovo divadlo

Arbesovo náměstí

.....



14

Výchozí zastávka / Starting stop  
**SPOŘILOV**

Tato zastávka / This stop  
**Těšnov**  
Zastávka na znamení / Request stop

Neděle 13. 10. 15:49

Cíl / Destination  
**VLTAVSKÁ**

Štvanice

Vltavská

Štrossmayerovo nám.

Kamenická

Letenské náměstí

Korunovační

Sparta

Chotkovy sady

Malostranská

Hellichova

Újezd

Švandovo divadlo

Arbesovo náměstí

.....



14

Výchozí zastávka / Starting stop  
**SPOŘILOV**

Tato zastávka / This stop  
**Těšnov**  
Zastávka na znamení / Request stop

**Neděle 13. 10. 15:49**

Cíl / Destination  
**VLTAVSKÁ**

Štvanice

Vltavská

Štrossmayerovo nám.

Kamenická

Letenské náměstí

Korunovační

Sparta

Chotkovy sady

Malostranská

Hellichova

Újezd

Švandovo divadlo

Arbesovo náměstí

.....



14

Výchozí zastávka / Starting stop  
**SPOŘILOV**

▼

Příští zastávka / Next stop  
**Štvanice**  
Zastávka na znamení / Request stop

**Neděle 13. 10. 15:49**

Cíl / Destination  
**VLTAVSKÁ**

*Vltavská*

*Strossmayerovo nám.*

*Kamenická*

*Letenské náměstí*

*Korunovační*

*Sparta*

*Chotkovy sady*

*Malostranská*

*Malostranské náměstí*

*Újezd*

*Švandovo divadlo*

*Arbesovo náměstí*

*Anděl*

.....



14

Výchozí zastávka / Starting stop  
**SPOŘILOV**

Tato zastávka / This stop  
**Štvanice**  
Zastávka na znamení / Request stop

**Neděle 13. 10. 15:49**

Cíl / Destination  
**VLTAVSKÁ**

*Vltavská*   
*Strossmayerovo nám.*  
*Kamenická*  
*Letenské náměstí*  
*Korunovační*  
*Sparta*  
*Chotkovy sady*  
*Malostranská*   
*Malostranské náměstí*  
*Hellichova*  
*Újezd*  
*Švandovo divadlo*  
*Arbesovo náměstí*  
*Anděl*





14

Výchozí zastávka / Starting stop  
**SPOŘILOV**

Tato zastávka / This stop  
**Štvanice**  
Zastávka na znamení / Request stop

**Neděle 13. 10. 15:49**

Cíl / Destination  
**VLTAVSKÁ**

Vltavská

Štrossmayerovo nám.

Kamenická

Letenské náměstí

Korunovační

Sparta

Chotkovy sady

Malostranská

Malostranské náměstí

Hellichova

Újezd

Švandovo divadlo

Arbesovo náměstí

Anděl

.....



14



Výchozí zastávka / Starting stop  
**SPOŘILOV**

▼

Příští zastávka / Next stop  
**Vltavská**  
Přestup / Transfer 

**Neděle 13. 10. 15:50**

Cíl / Destination  
**VLTAVSKÁ**

Strossmayerovo nám.  
Kamenická  
Letenské náměstí  
Korunovační  
Sparta  
Choťkovy sady  
Malostranská   
Malostranské náměstí  
Hellichova  
Újezd  
Švandovo divadlo  
Arbesovo náměstí  
Anděl   
Na Knížecí 

.....



14

Výchozí zastávka / Starting stop  
**SPOŘILOV**

Tato zastávka / This stop  
**Vltavská**  
Přestup / Transfer

**Neděle 13. 10. 15:50**

Cíl / Destination  
**VLTAVSKÁ**

Strossmayerovo nám.  
Kamenická  
Letenské náměstí  
Korunovační  
Sparta  
Choťkovy sady  
Malostranská   
Malostranské náměstí  
Hellichova  
Újezd  
Švandovo divadlo  
Arbesovo náměstí  
Anděl   
Na Knížecí

.....



14

Výchozí zastávka / Starting stop  
**SPOŘILOV**

**Neděle 13. 10. 15:50**

Cíl / Destination  
**VLTAVSKÁ**

Tato zastávka / This stop  
**Vltavská**  
Přestup / Transfer

Strossmayerovo nám.  
Kamenická  
Letenské náměstí  
Korunovační  
Sparta  
Choťkovy sady  
Malostranská   
Malostranské náměstí  
Hellichova  
Újezd  
Švandovo divadlo  
Arbesovo náměstí  
Anděl   
Na Knížecí

.....



14

Výchozí zastávka / Starting stop  
**VLTAVSKÁ**

Tato zastávka / This stop  
**Vltavská**  
Přestup / Transfer

**Neděle 13. 10. 15:50**

Cíl / Destination  
**VOZOVNA MOTOL**

Strossmayerovo nám.

Nábřeží Kap. Jaroše

Dlouhá třída

Náměstí Republiky

Masarykovo nádr.

Jindřišská

Václavské nám.

Vodičkova

Lazarská

Karlovo náměstí

Moraň

Palaského náměstí

Zborovská

Anděl

.....



# 14



Vlak jede do vozovny  
The train terminates  
at the tram depot

Výchozí zastávka / Starting stop  
**VLTAVSKÁ**

Tato zastávka / This stop  
**Vltavská**  
Přestup / Transfer 

**Neděle 13. 10. 15:50**

Cíl / Destination  
**VOZOVNA MOTOL**

Strossmayerovo nám. 

Nábřeží Kap. Jaroše 

Dlouhá třída

Náměstí Republiky 

Masarykovo nádr. 

Jindřišská

Václavské nám. 

Vodičkova 

Lazarská

Karlovo náměstí

Moraň

Palaského náměstí 

Zborovská

Anděl 

.....



# 12





Vlak jede do vozovny  
The train terminates  
at the tram depot

Výchozí zastávka / Starting stop  
**VLTAVSKÁ**

Tato zastávka / This stop  
**Strossmayerovo nám.**

**Neděle 13. 10. 15:51**

Cíl / Destination  
**VOZOVNA MOTOL**

Kamenická  
Letenské náměstí  
KorunovačnÍ  
Sparta  
Chotkovy sady  
Malostranská   
Malostranské náměstí  
Hellichova  
Újezd  
Švandovo divadlo  
Arbesovo náměstí  
Anděl   
Bertramka  
U Zvonu  
.....



# 12

**Vlak jede do vozovny**  
 The train terminates  
 at the tram depot

Výchozí zastávka / Starting stop  
**VLTAVSKÁ**

Tato zastávka / This stop  
**Strossmayerovo nám.**

**Neděle 13. 10. 15:51**

Cíl / Destination  
**VOZOVNA MOTOL**

Kamenická  
Letenské náměstí  
KorunovačnÍ  
Sparta  
Chotkovy sady  
Malostranská   
Malostranské náměstí  
Hellichova  
Újezd  
Švandovo divadlo  
Arbesovo náměstí  
Anděl   
Bertramka  
U Zvonu  
.....





# 20

Změna v dopravě  
Traffic change

Výchozí zastávka / Starting stop

DĚDINA

Příští zastávka / Next stop

Červený Vrch

Neděle 13. 10. 16:05

Cíl / Destination

NÁDRAŽÍ PODBABA

Sídli. Červený Vrch  
Bořislavka  
Na Pískách  
Hadovka  
Thákurova  
Dejvická



# 20

Změna v dopravě  
Traffic change

Výchozí zastávka / Starting stop

## DĚDINA

Tato zastávka / This stop

### Červený Vrch

Neděle 13. 10. 16:05

Cíl / Destination

## NÁDRAŽÍ PODBABA

Síd. Červený Vrch  
Bořislavka  
Na Pískách  
Hadovka  
Thákurova  
Dejvická



# 20

Změna v dopravě  
Traffic change

Výchozí zastávka / Starting stop

## DĚDINA

Tato zastávka / This stop

### Červený Vrch

Neděle 13. 10. 16:05

Cíl / Destination

## NÁDRAŽÍ PODBABA

Sídli. Červený Vrch  
Bořislavka  
Na Pískách  
Hadovka  
Thákurova  
Dejvická



# 20

Změna v dopravě  
Traffic change

Výchozí zastávka / Starting stop  
**DĚDINA**

Tato zastávka / This stop  
**Thákurova**

Dejvická

**Neděle 13. 10. 16:05**

Cíl / Destination  
**NÁDRAŽÍ PODBABA**



# 20

Změna v dopravě  
Traffic change

Výchozí zastávka / Starting stop  
**DĚDINA**

Tato zastávka / This stop  
**Thákurova**

Dejvická

**Neděle 13. 10. 16:05**

Cíl / Destination  
**NÁDRAŽÍ PODBABA**



# 20

!

**Změna v dopravě**  
Traffic change

Výchozí zastávka / Starting stop

DĚDINA

▼

Příští zastávka / Next stop

Dejvická

Přestup / Transfer

Neděle 13. 10. 16:05

Cíl / Destination

NÁDRAŽÍ PODBABA



# 20

!

**Změna v dopravě**  
Traffic change

Výchozí zastávka / Starting stop

## DĚDINA

Tato zastávka / This stop

### Dejvická

Přestup / Transfer

Neděle 13. 10. 16:05

Cíl / Destination

## NÁDRAŽÍ PODBABA

Lotyšská  
Zelená  
NÁDR. PODBABA



# 20

!

**Změna v dopravě**  
Traffic change

Výchozí zastávka / Starting stop  
**DĚJICKÁ**

Tato zastávka / This stop  
**Dejvická**

Přestup / Transfer

**Neděle 13. 10. 16:05**

Cíl / Destination  
**NÁDRAŽÍ PODBABA**

Lotyšská  
Zelená  
**NÁDR. PODBABA**



195

Konečná zastávka / Final stop

→ SKALKKA 

Přes zastávky / Via

Skalkka  - Zahradní Město - Sídl.Zahradní Město

15:55



Pásmo / Zone

 Donatellova
 
Skalkka 

 Na Padesátém

 Nádr. Zahradní Město 

 Zahradní Město
 

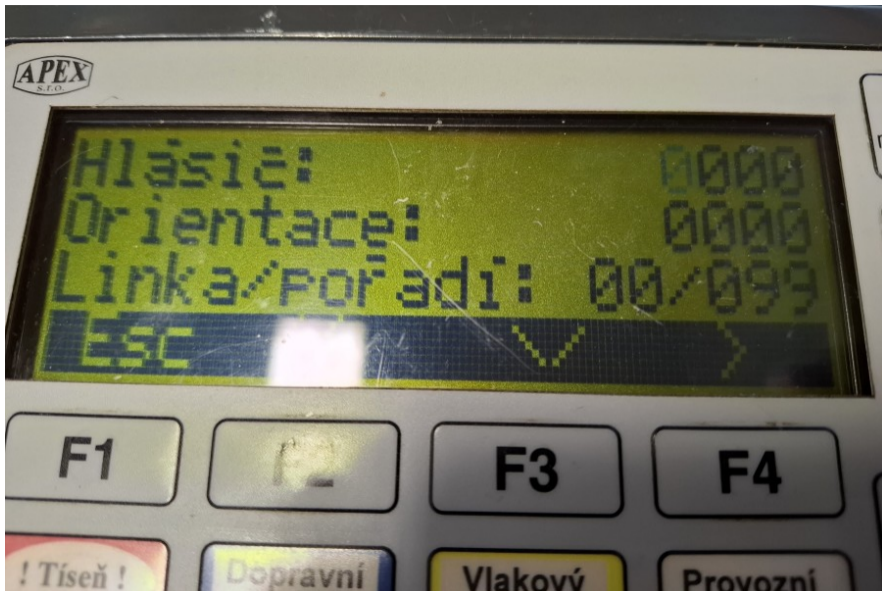



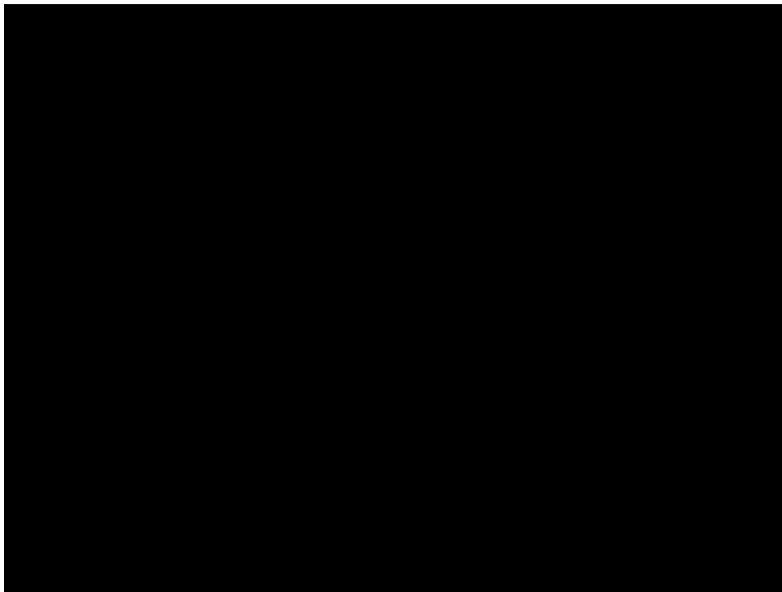



American  
Megatrends

Version 2.14.1219. Copyright (C) 2011 American Megatrends, Inc.  
iTX-a55E3 BIOS Rev:1.11



# American Megatrends

Version 2.14.1219. Copyright (C) 2011 American Megatrends, Inc.

iTX-a55E3 BIOS Rev:1.11

Press <DEL> or <F2> to enter setup.

Press <F11> for BBS POPUP.

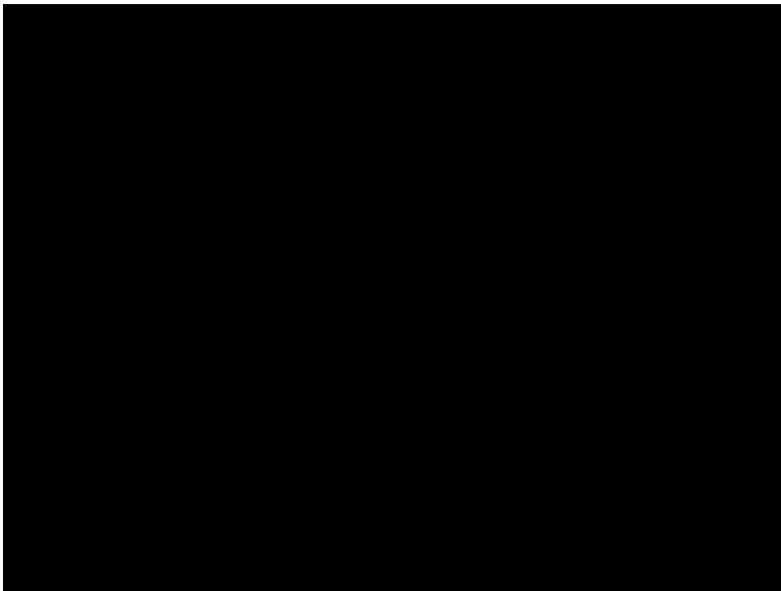

Start

User 

















Windows Embedded 8  
Build 9200

Příznak	Zastávka	Čas JŘ	Odchyłka
Pásmo	Služba	Datum	Čas
	921 00 00	13.10.24	16:10:03

		VR+KA			Cíl
		KL+HO			Poloha
		ŘE			Služba

Příznak	Zastávka	Čas	IŘ	Odchyłka
Pásmo	921			Čas
				10:03
				Cíl
				Poloha
				Služba

Zadejte číslo služby

921 00 00

1	2	3	⌫
4	5	6	◀
7	8	9	▶
0		✓	✗

Příznak	Zastávka	Čas	IŘ	Odchyłka
Pásmo				Čas
	921			10:03
<b>Zadejte číslo služby</b>				
921 00 00				
1 2 3				
4 5 6				
7 8 9				
0				
<b>Přihlaste se prosím.</b>				
Cíl				
Poloha				
Služba				

The image shows a mobile application interface for bus services. A modal dialog box is open, prompting the user to enter a service number. The number '921 00 00' is entered. A blue box with the text 'Přihlaste se prosím.' (Please log in) and a red 'X' is overlaid on the dialog, indicating a login requirement. The background shows a table with columns for 'Příznak', 'Zastávka', 'Čas', 'IŘ', and 'Odchyłka'. The 'Pásmo' (Zone) is '921' and the 'Čas' (Time) is '10:03'. A bottom bar contains icons for a warning, a smartphone, and a bus stop, along with a navigation bar with 'Cíl', 'Poloha', and 'Služba' buttons.

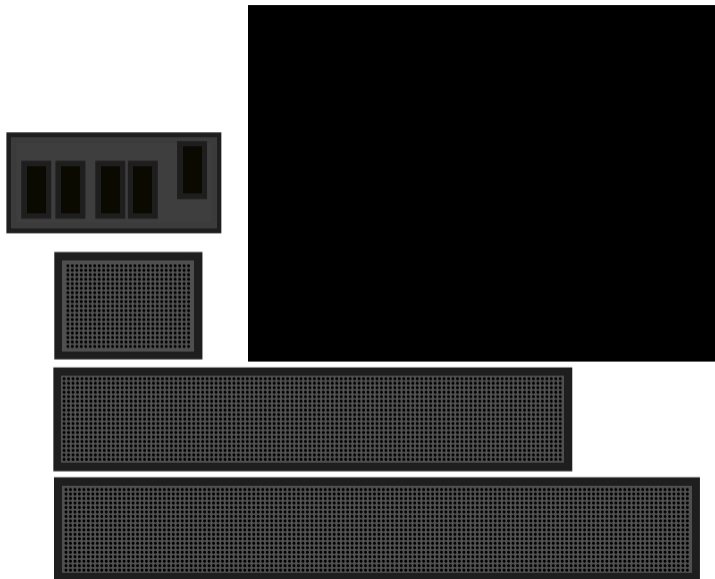

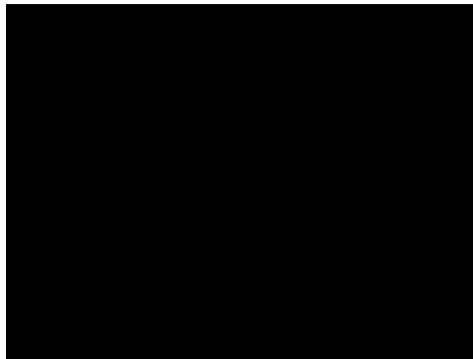
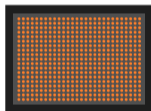

MANIPULAČNÍ JÍZDA

MANIPULAČNÍ JÍZDA

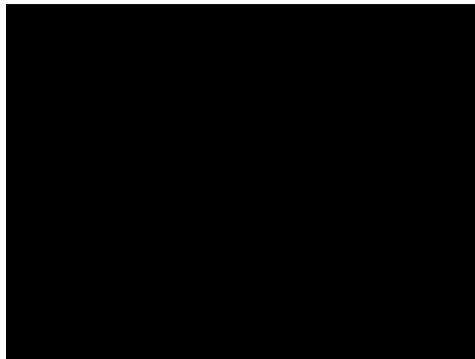
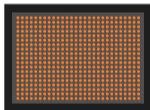

MANIPULAČNÍ JÍZDA

MANIPULAČNÍ JÍZDA



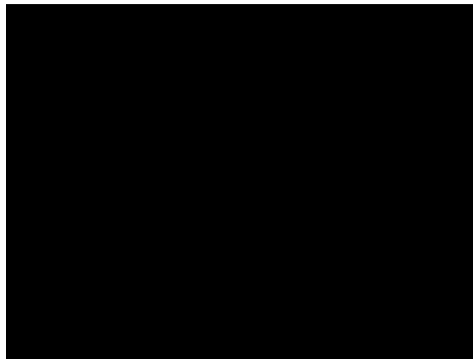
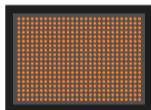

MANIPULAČNÍ JÍZDA

MANIPULAČNÍ JÍZDA

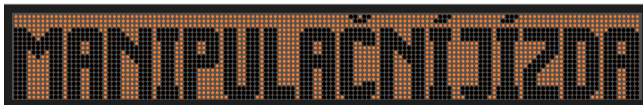
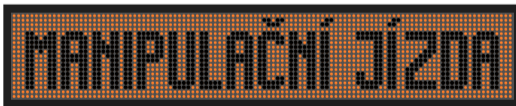
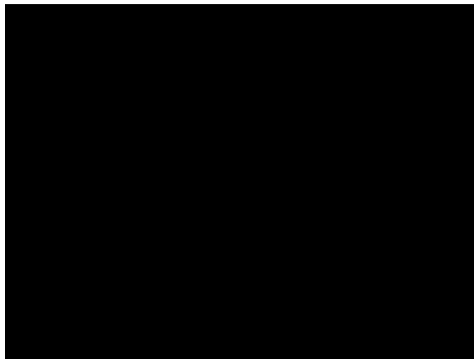
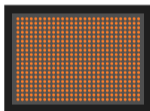

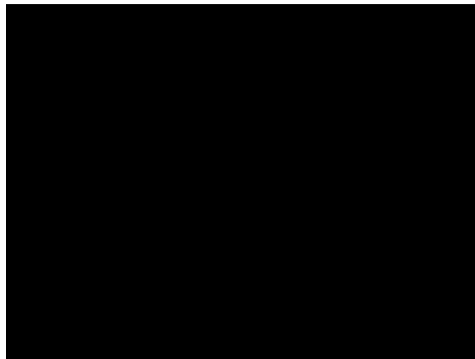
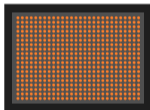

MANIPULAČNÍ JÍZDA

MANIPULAČNÍ JÍZDA

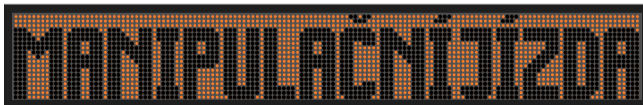
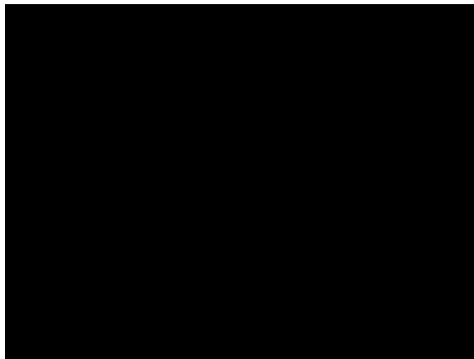
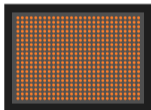

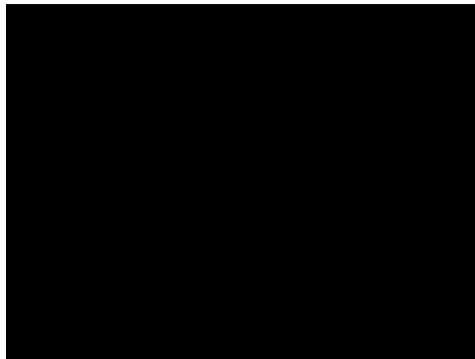
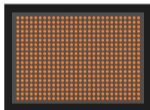

MANIPULAČNÍ JÍZDA

MANIPULAČNÍ JÍZDA

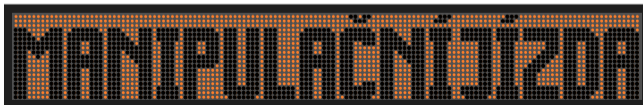
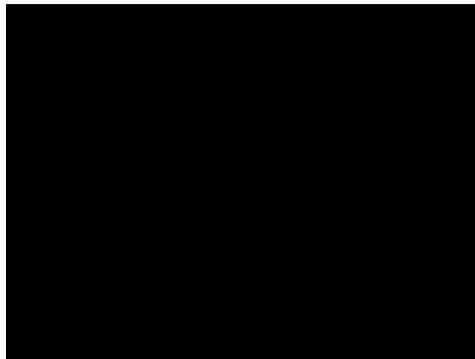
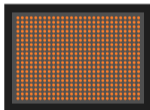

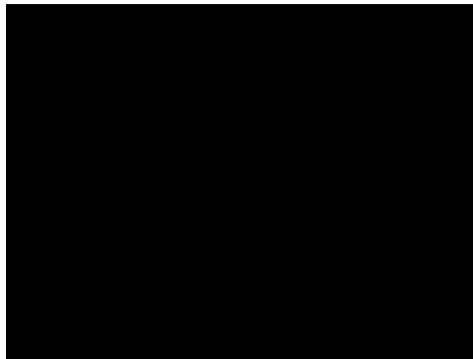
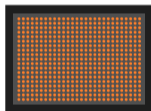

MANIPULAČNÍ JÍZDA

MANIPULAČNÍ JÍZDA

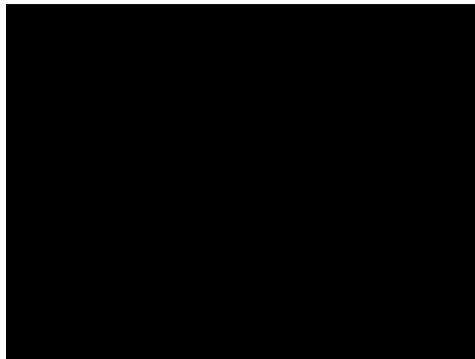
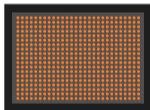

MANIPULAČNÍ JÍZDA

MANIPULAČNÍ JÍZDA



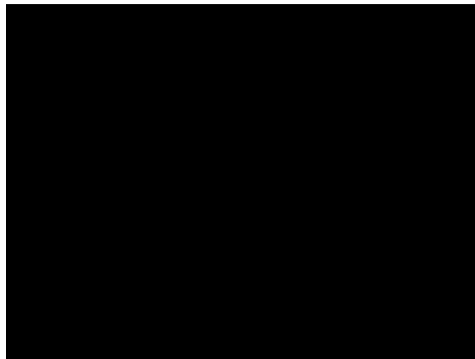
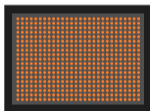

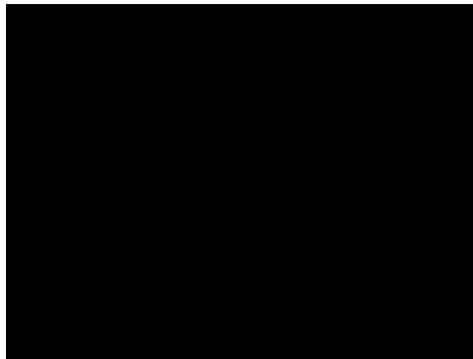
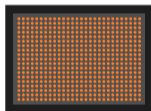

MANIPULAČNÍ JÍZDA

MANIPULAČNÍ JÍZDA

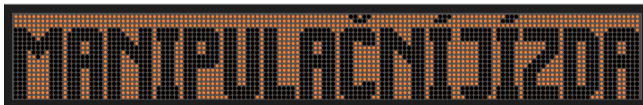
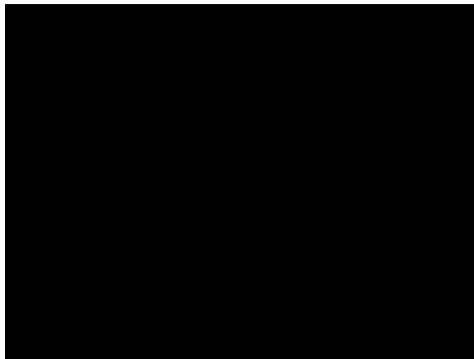
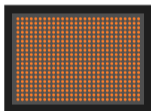

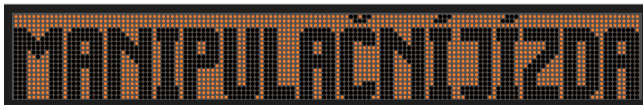
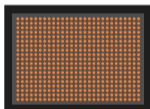

Award Modular Bios v4.51PG, An Energy Star Ally  
Copyright (C) 1984-98, Award Software, Inc.



LE-375ME VER: 1.942

Main Processor : Intel (R) Atom(TM) 1.333 MHz  
Memory Testing : 1048576K OK = CPU shared memory  
CPU BRAND NAME : Intel(R) Atom(TM) CPU Z520PT @ 1.333 MHz  
CPU BIOS Registred  
Hyper-Threading Technology CPU Detected (Hyper-Treading Enabled)

Memory Programing for BIOS  
Loading Drivers...

Press DEL for entering SETUP  
02/22/2011-FULLSMD-0M75TPC-00

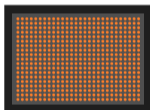

```

CPU Clock      : 1.3333GHz      Cache Memory   : 120K
Pri. Master Disk : None        Display Type   : EGA/UGA
Pri. Slave Disk  : None        Serial Port(s) : 3F8
Sec. Master Disk : None        Parallel Port(s) : None
Sec. Slave Disk  : None        DDR2 SDRAM at Rank : 01

USB Storage Device : Generic USB SD Reader 1.00...High Speed device 2.X

PCI device listing ...
Bus No. Device No. Func No. Vendor/Device Class Device Class      IRQ
-----
0      15      0      1106  5324  0101 IDE Cntrlr      14
0      16      0      1106  3030  0C03 USB 1.0/1.1 UHCI      10
0      16      0      1106  3030  0C03 USB 1.0/1.1 UHCI      5
0      16      0      1106  3030  0C03 USB 1.0/1.1 UHCI      11
0      16      0      1106  3104  0C03 USB 2.0 EHCI Cnt      3
1      15      0      1106  3157  0300 Display Cntrlr      10
2      15      0      1106  3200  0403 Multimedia Device    5
3      15      0      1106  3106  0200 Network Cntrlr      11

Verifying DMI Pool Data .....

```

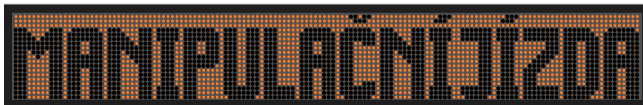

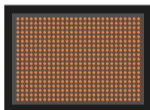

```
SYSLINUX 4.01 0x4c3de821 EDD Copyright (C) 1984-2018 H. Peter Anvin et al
Loading vmlinuz....
Loading initrd....ready
```

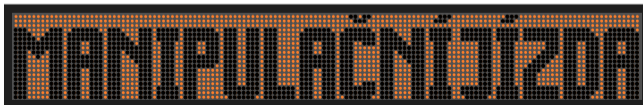

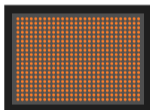

```
Loading drivers module to detect disk drivers.
```

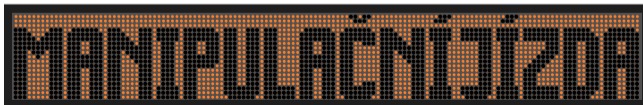

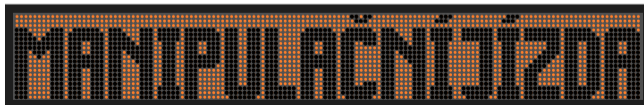
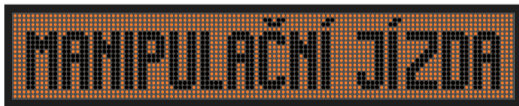
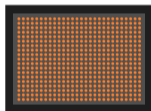

```
Loading drivers module to detect disk drivers... done  
Searching for Poppy files to computer disk drivers... done
```



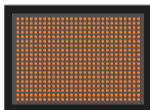

```
Loading drivers module to detect disk drivers... done
Searching for Poppy files to computer disk drivers... done
Loading the 'Image_S52.mfs' mainfiles... coping to ram
```

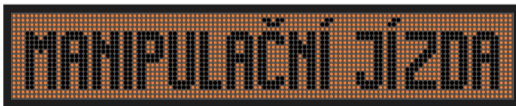
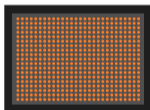

```
Loading drivers module to detect disk drivers... done
Searching for Poppy files to computer disk drivers... done
Loading the 'Image_S52.mfs' main files... coping to ram done
Booting up the layered filesystem... done
Performing a 'mitch_root' to the layered filesystem... done
Making the filesystem readable... done
```

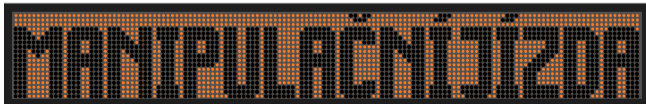
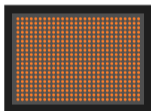

```
Loading drivers module to detect disk drivers... done
Searching for Poppy files to computer disk drivers... done
Loading the 'Image_S52.mfs' main files... coping to ram done
Booting up the layered filesystem... done
Performing a 'mitch_root' to the layered filesystem... done
Making the filesystem readable... done
Loading kernel modules... done
```

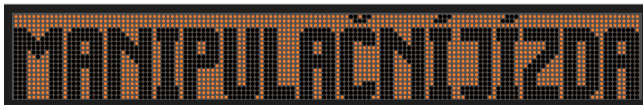
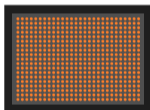

```
Loading drivers module to detect disk drivers... done
Searching for Poppy files to computer disk drivers... done
Loading the 'Image_S52.mfs' main files... coping to ram done
Booting up the layered filesystem... done
Performing a 'mitch_root' to the layered filesystem... done
Making the filesystem readable... done
Loading kernel modules... done
Waiting for modules to complete loading... usb done
```

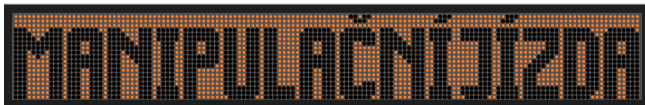
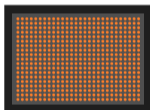

```
Loading drivers module to detect disk drivers... done
Searching for Poppy files to computer disk drivers... done
Loading the 'Image_S52.mfs' main files... coping to ram done
Booting up the layered filesystem... done
Performing a 'mitch_root' to the layered filesystem... done
Making the filesystem readable... done
Loading kernel modules... done
Waiting for modules to complete loading... usb done
Setting up services (ports, printing, etc.)... (background)
```

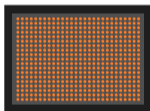

```
Loading drivers module to detect disk drivers... done
Searching for Poppy files to computer disk drivers... done
Loading the 'Image_S52.mfs' main files... coping to ram done
Booting up the layered filesystem... done
Performing a 'mitch_root' to the layered filesystem... done
Making the filesystem readable... done
Loading kernel modules... done
Waiting for modules to complete loading... usb done
Setting up services (ports, printing, etc)... (background)
Detecting media devices... original input
```

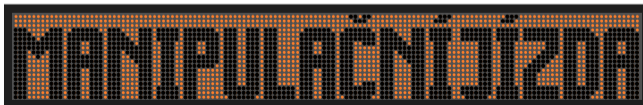
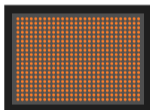

```

Loading drivers module to detect disk drivers... done
Searching for Poppy files to computer disk drivers... done
Loading the 'Image_SS2.mfs' main files... coping to ram done
Booting up the layered filesystem... done
Performing a 'mitch_root' to the layered filesystem... done
Making the filesystem readable... done
Loading kernel modules... done
Waiting for modules to complete loading... usb done
Setting up services (ports, printing, etc)... (background)
Detecting media devices... original input

login(SS2): root login as 'tty1'

```

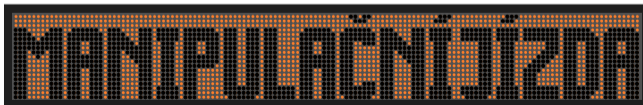
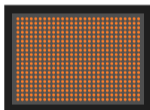

```

Loading drivers module to detect disk drivers... done
Searching for Poppy files to computer disk drivers... done
Loading the 'Image_S52.mfs' main files... coping to ram done
Booting up the layered filesystem... done
Performing a 'mitch_root' to the layered filesystem... done
Making the filesystem readable... done
Loading kernel modules... done
Waiting for modules to complete loading... usb done
Setting up services (ports, printing, etc)... (background)
Detecting media devices... original input

login(SS2): root login as 'tty1'
cat: /etc/oldsystemdevices: No such file or directory
-

```



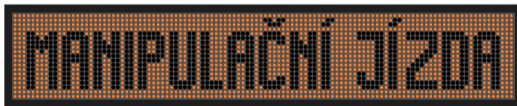
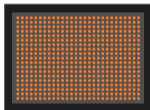

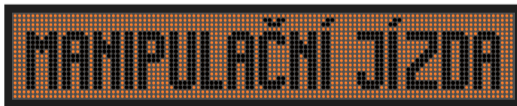
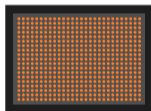

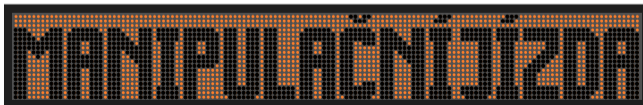
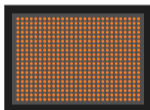

# Závěr

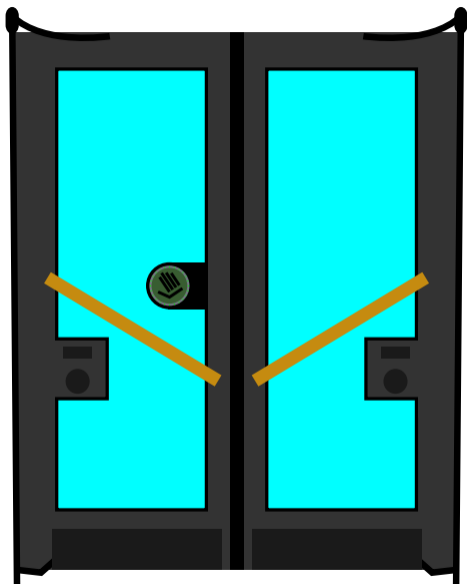

# Jak vystupovat na zastávkách které jsou nově na znamení?

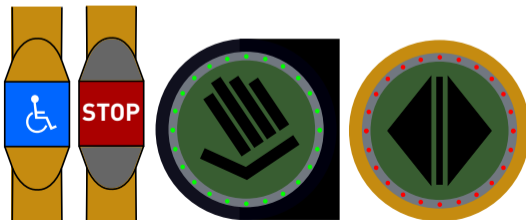





# Děkuji za pozornost.

Tomáš Tichý

 @TomTich2

 @tichytom

Tato prezentace je k dispozici ke stažení: <https://tichytom.cz>